

**IMPORTANT USER INSTRUCTIONS:**

Automatic gate systems provide user convenience and limit vehicular traffic. Because these systems can produce high levels of force, it is important that you are aware of the potential hazards associated with the system. Potential hazards may include pinch points, entrapment positions, lack of proper pedestrian access, blind spots for traffic visibility.

It is the joint responsibility of the designer, purchaser, installer and end user to verify the system is properly configured for its intended use. Be sure that the installer has instructed you on the proper operation of the gate and gate system before use. Be sure the installer trains you about the basic functions of the required reversing devices associated with the gate system and how to properly test them. Reversing devices may include reverse loops, sensing edges, photoelectric cells, inherent reverse detection, and/or other external devices.

**RESTRICTIONS & WARNINGS:**

1. A moving gate can cause serious injury or death. Read and follow all installation manuals, reference manuals, and warning label instructions.
2. Vehicular gates are for vehicles only. Pedestrians must use a separate entrance. Keep all pedestrian traffic away from any vehicular gate. No one should cross the path of a moving gate.
3. Never allow children to operate or play with gate controls or to play in the area of a gate system.
4. Access control devices must be placed far enough from moving gates to prevent the user from coming in contact with the gate while operating the controls.
5. All activating devices must be installed in a clear line-of-sight with the gate and its travel.
6. Activating devices must be installed a minimum of 10 feet away from the gate.
7. Outdoor or easily accessible controls shall have a security feature to prevent unauthorized use.
8. Be sure to mount all operating devices clearly out of reach of through gates.
9. **DO NOT** install this device unless all potential hazards and pinch points have been eliminated.

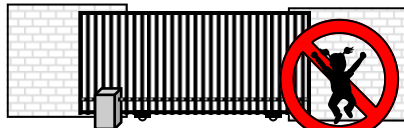

**!** DO NOT allow children to play near, on or with the gate, gate operator, or any of its controls.

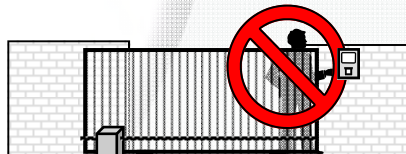

**!** DO NOT mount operating devices accessible through the gate or in between gate and wall.



**Product Manual**

- Installation Instructions
- Wiring Instructions

### MOUNTING THE SYSTEM:

The system can be mounted on a standard pedestal or directly to a wall or flat surface. A 3/4" knockout is located on the back of the box for conduit connections. Rear mounting holes are available for mounting screws and anchors. Follow all safety warnings and precautions when mounting the system.

**IMPORTANT: Remove the TDM100 before removing the knockout to prevent damage.**

#### Pedestal Mounting:

1. Use security screws and lock nuts to securely attach the back box to a gooseneck post.
2. If the mounting holes are not used, fill the holes with a plug or sealant to prevent water from entering the box.

#### Wall Mounting:

1. Mount the system to a wall or flat surface. Use appropriate mounting screws or anchors to securely attach the system.
2. Never mount the system to a moving gate, gate panel, or next to a gate that causes vibration to the mounting point. Continuous vibration from moving or slamming gates can cause damage to the unit and is not covered under warranty.

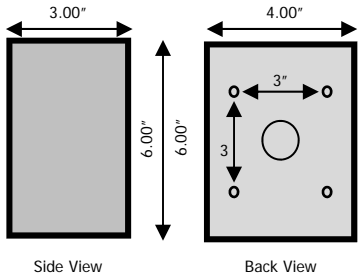

**DO NOT** mount operating devices accessible through the gate or in between gate and wall.

Mount the system at least 10 feet away from a vehicular gate and its travel.

### LED LIGHT WIRING:

The FEB100-PB has a built-in LED light for night time use. The LED light is located on the top of the recessed light box. To power the LED light:

1. Connect a 12-24VAC/VDC power source to the LED Power Terminal.

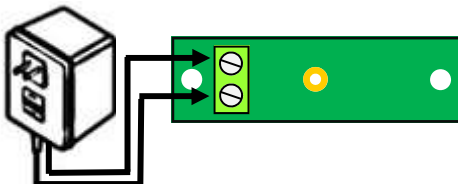

### PUSHBUTTON LIGHT WIRING:

The FEB100-PB has an angel eye LED light around the button for night time use. **The LED light can only be powered by 12VDC.** To power the light:

1. **Connect only a 12VDC** power source to the pushbutton red wires. These wires may be connected to the TDM100 module power as long as it is a **12VDC supply.**

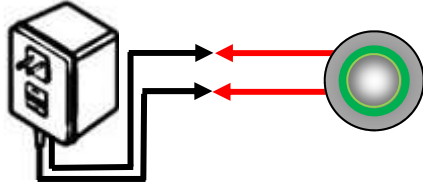

### TDM100 WIRING OVERVIEW:

The FEB100-PB uses the TDM100 Time Delay Module for relay and time delay control. The time delay can be set from 1 - 99 seconds or in a toggle mode.

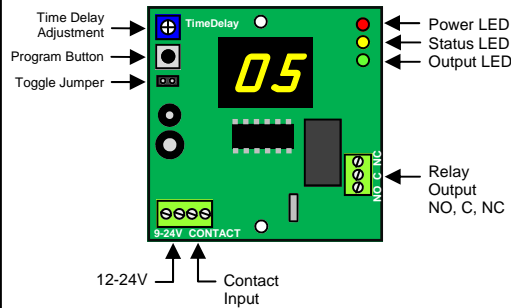

### TDM100 POWER WIRING:

The TDM100 can be powered by a 12-24VAC/VDC power source. The LED light can be connected in line with the TDM100 power. The Pushbutton light can be connected in line with the TDM100 power only if the power source is 12VDC. To connect power:

1. Connect a 12-24VAC/VDC power source to the LED Power Terminal.

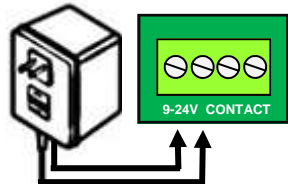

### TDM100 RELAY WIRING:

The TDM100 module has one relay with NO, NC, C inputs. To connect a device to the TDM100 relay:

1. Connect gate operators to NO and C
2. Connect electric strikes to NO and C
3. Connect magnetic locks to NC and C

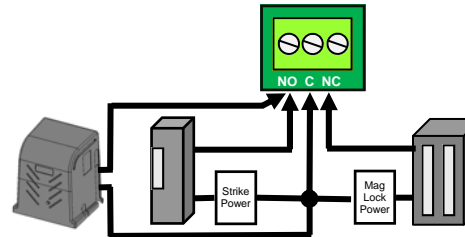

### TIME DELAY PROGRAMMING:

The time delay can be set from 1 - 99 seconds. To adjust the time delay:

1. Place the Toggle Jumper on only one pin.

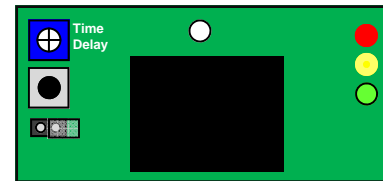

2. Turn power on.

- Red LED should be on and Count LED should show 00 while Yellow LED is on.
- Yellow LED and Count LED will turn off after 2 seconds.

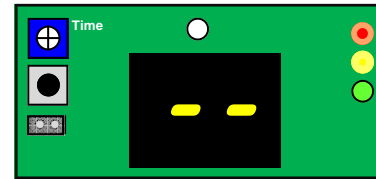

3. Press the program button. The current time delay will be displayed.

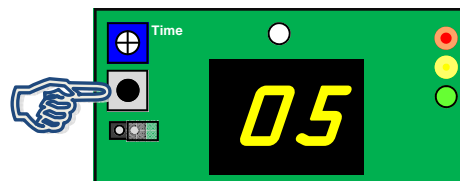

### TIME DELAY PROGRAMMING (CONT):

4. Using a small screw driver, adjust the time delay by turning the Time Delay POT on the top right.

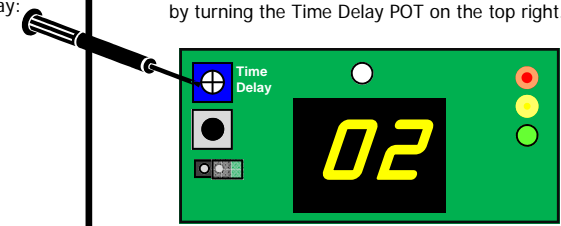

5. Press the program button to save the new setting. Display will blink --, then -- solid, then turn off.

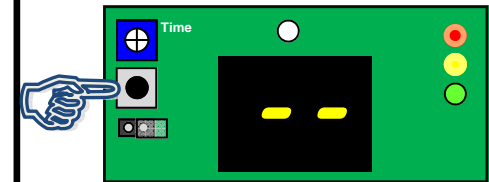

### TOGGLE MODE PROGRAMMING:

The time delay can be turned off and set to a toggle mode. To adjust the time delay:

1. Place the Toggle Jumper on both pins.

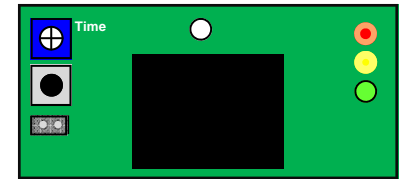

2. Turn power on. System will toggle the relay each time the pushbutton is pressed.

- If relay is inactive, input will activate relay.
- If relay is active, input will deactivate relay.

